

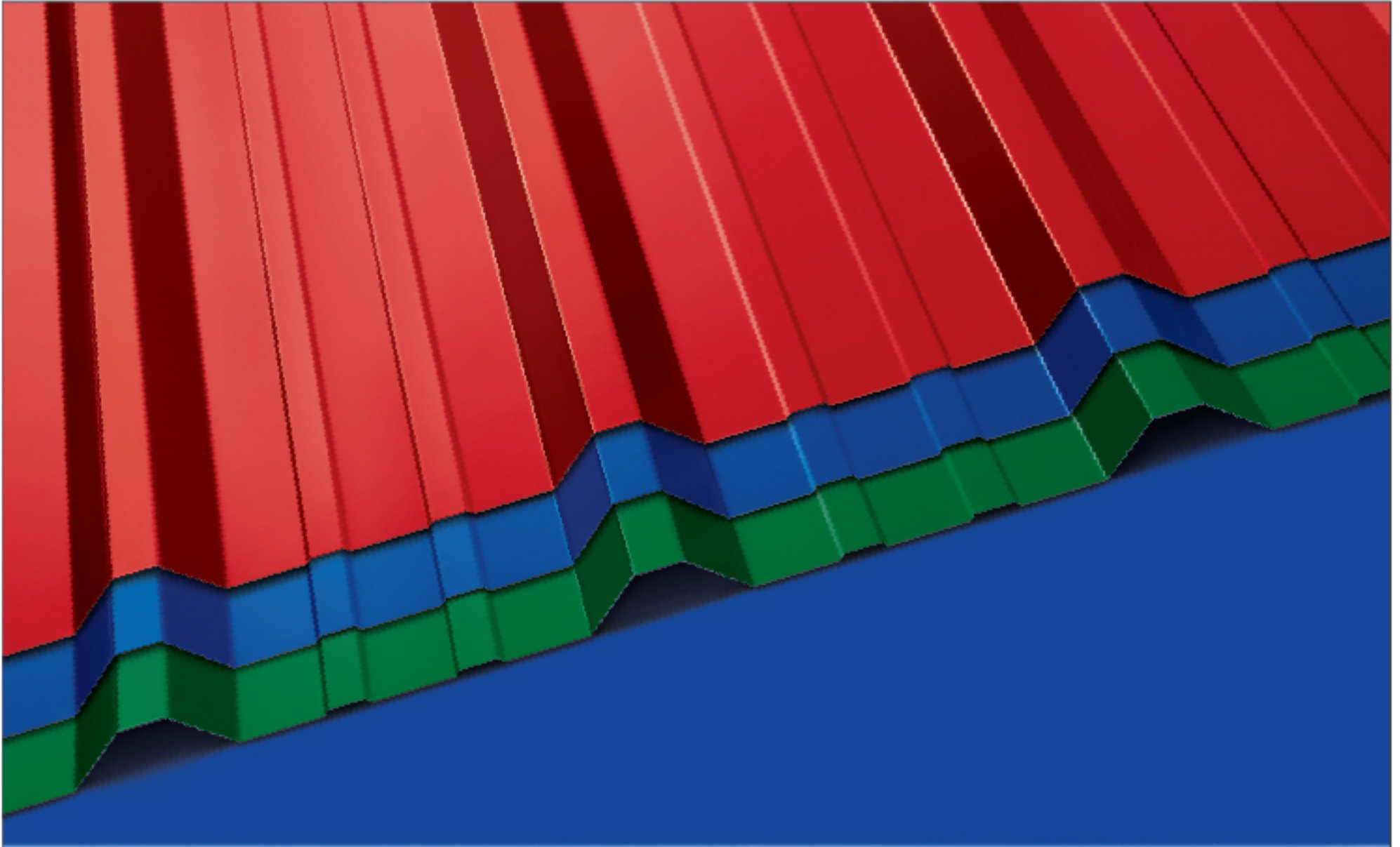

JSW Colouron+
Premium Colour Coated Roofing Sheets

**BEAUTY THAT
LASTS FOREVER**

JSW Steel





ABOUT US

JSW Steel Coated Products Limited (JSWSCPL) is a 100% subsidiary of JSW Steel, one of India's biggest steel producers and the flagship company of JSW Group that also boasts of a formidable presence in Energy, Cement and Ports. Driven by the speed and innovation that its parent company is known for, JSW Steel Coated Products Limited has witnessed exponential growth since its inception and now has state-of-the-art manufacturing facilities at Vasind, Tarapur and Kalmeshwar in Maharashtra.

MILESTONES IN THE STEEL INDUSTRY

- ▶ Wide range of products include Hot rolled, Cold rolled, Galvanised, Galvalume, Colour coated, TMT Bars, Wire rod, Special Steel, Billets & Blooms, Electrical Steel
- ▶ Largest coated and colour-coated Steel Producer in India.
- ▶ India's first licensed Galvalume® producer.
- ▶ India's largest integrated special alloy steel plant.

PROUD MOMENT



Received the prestigious Prime Minister's Excellence Trophy 2012-13 for the Best Integrated Steel Plant

ADVANTAGES

ALUMINIUM-ZINC COATING

JSW Steel is the first licensee of Galvalume in India. Galvalume products offer superior corrosion-resistance compared to other coating technologies, making your roof last longer even in the harshest of weather conditions.

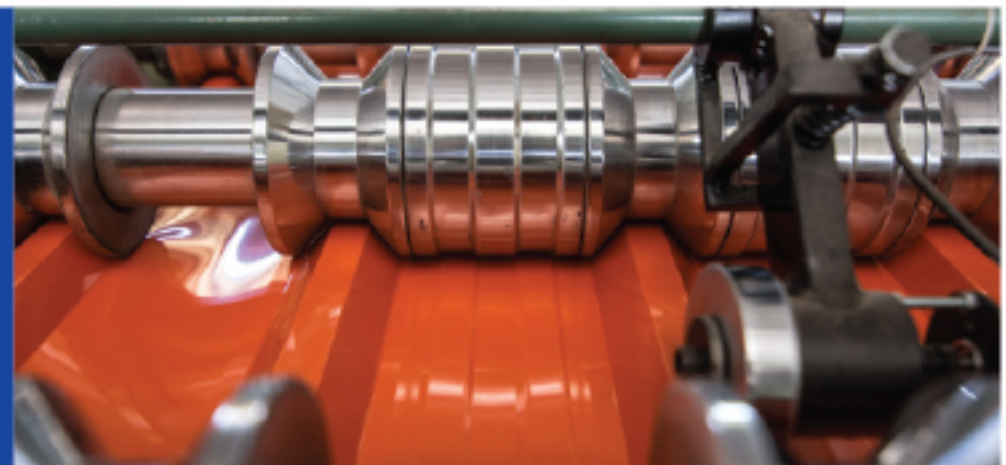

ANTI-CORROSION

It comes with Anti-Corrosion Technology that prevents early corrosion of steel and substantially increases the life of the roof.

ISI APPROVED

It is India's first ISI certified colour-coated sheets which shows the commitment of JSW Steel Coated Products Limited towards manufacturing world class products.



OPTIMUM TEMPERATURE MANAGEMENT

It stops heat radiation from penetrating inside the building, thus maintaining greater thermal comfort all year round and keeping the interiors cooler.



ALL WEATHER PROTECTION

It withstands all kinds of weather, be it heavy rains, salty sea air, humid coastal climate, cold snow or heat.

STRENGTH

Made from Pure Steel, it has high tensile strength at an optimal weight. It offers a yield strength of min 550 mpa and 770 mpa to meet the needs of various application.



SUPERIOR PAINT TECHNOLOGY

The paint of ordinary colour-coated sheets start fading very fast and in 1-2 years the roof starts looking dull and old. JSW Colouron+, however is colour-coated using superior paint technology that prevents cracking and peeling of the paint, ensuring the roof looks new even after many years.



STRINGENT QUALITY TESTS

Every JSW Colouron+ sheet undergoes stringent quality tests to ensure world-class quality.

ADVANCED TECHNOLOGY

JSW Steel uses the latest technology from Japan, USA and Italy to manufacture steel and steel products. Plus it, employs the best machinery to ensure the highest level of quality.



A WIDE RANGE OF COLOURS

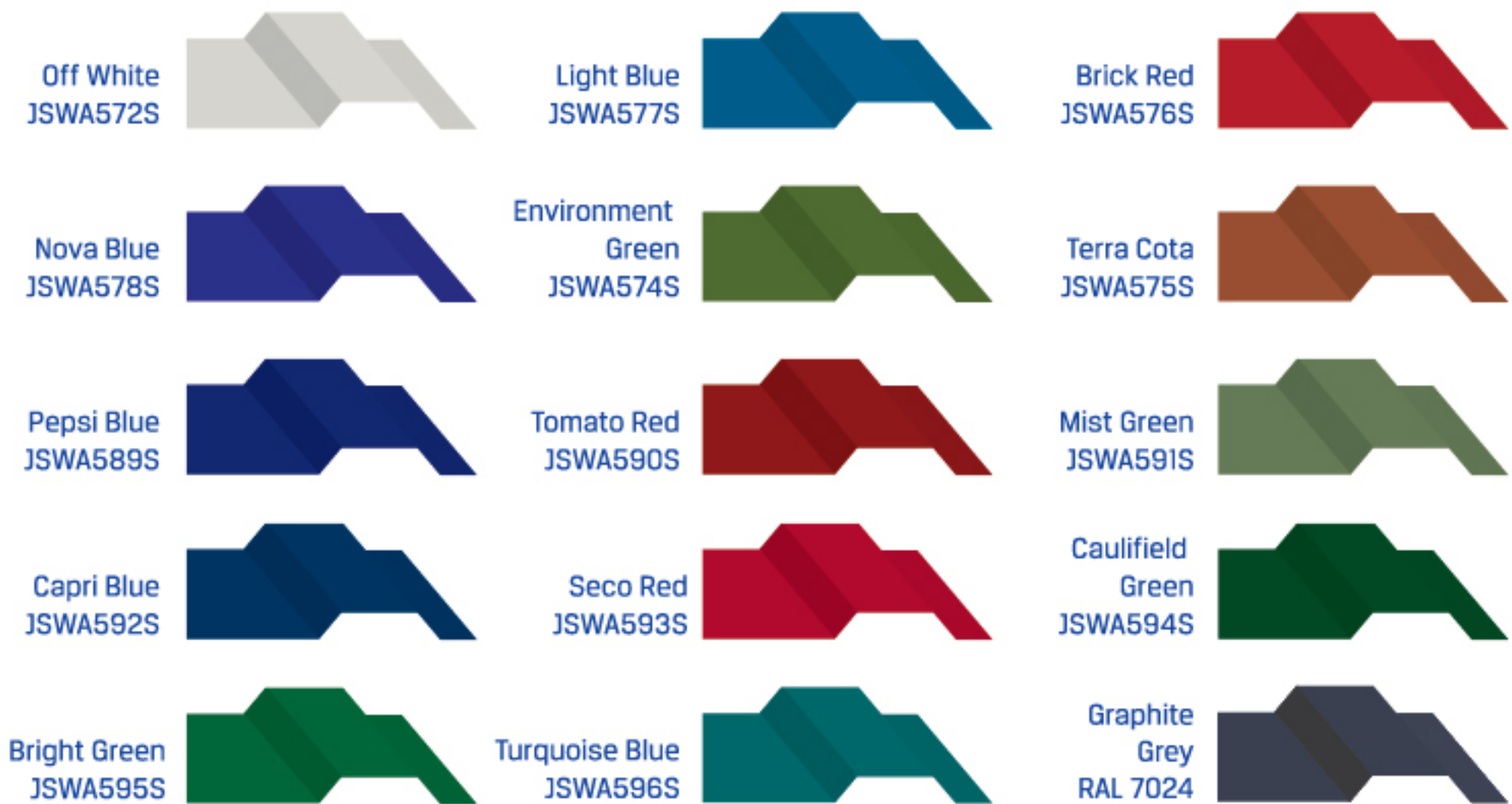

PRODUCT SPECIFICATIONS

COIL FORM	PPGL
Thickness (mm)	0.20-1.2
Width (mm)	600 - 1335
Substrate	Al-Zinc alloy steel
Zinc Coating (gsm)	70-200
Hardness (HRB)	55-65 Soft CQ, Above 85 for Grade 80
Guard film-optional (microns)	40µ (Customised also)
	ASTM A 755, EN 10169, IS 159

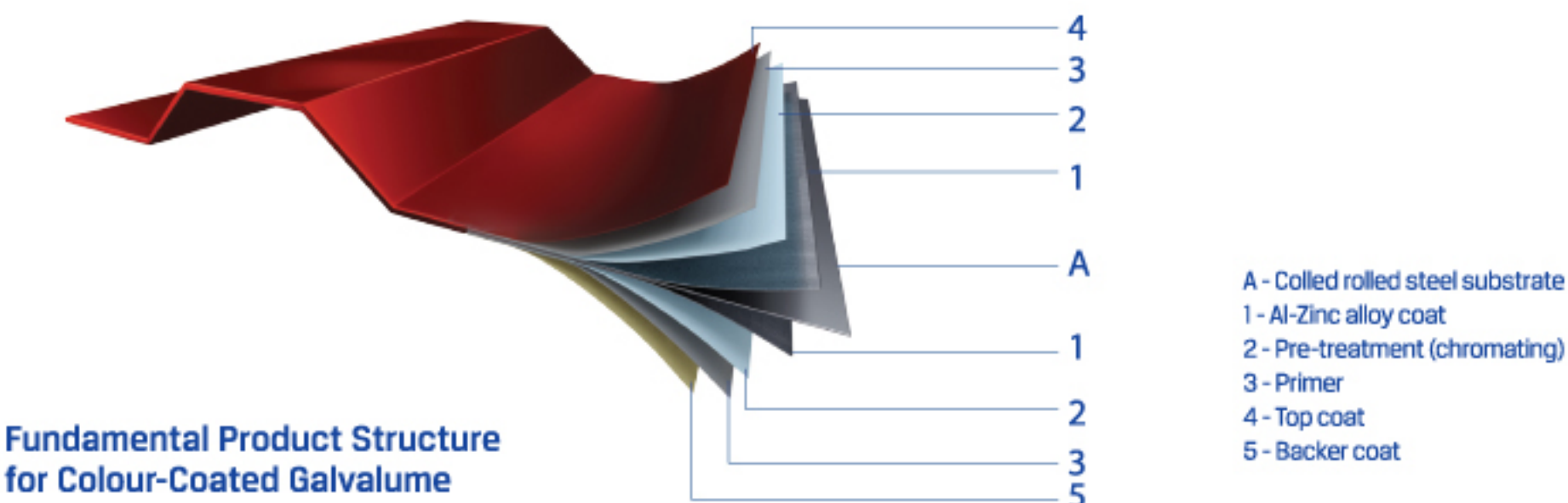



DIFFERENT DESIGNS



4ft WIDER - DOUBLE RIBBED TRAPEZOIDAL PROFILE

Thickness (TCTP in mm)	0.35, 0.40, 0.45, 0.50, 0.60
Effective Cover Width (mm)	1142
Overall Width (mm)	1220
Pitch (mm)	285.5 +/- 2.5
Crest Height (mm)	29 +/- 2
Length (ft)	8, 10, 12, 14, 16, 18, 20, 22, 24
Substrate	PPGL AZ70 & AZI50

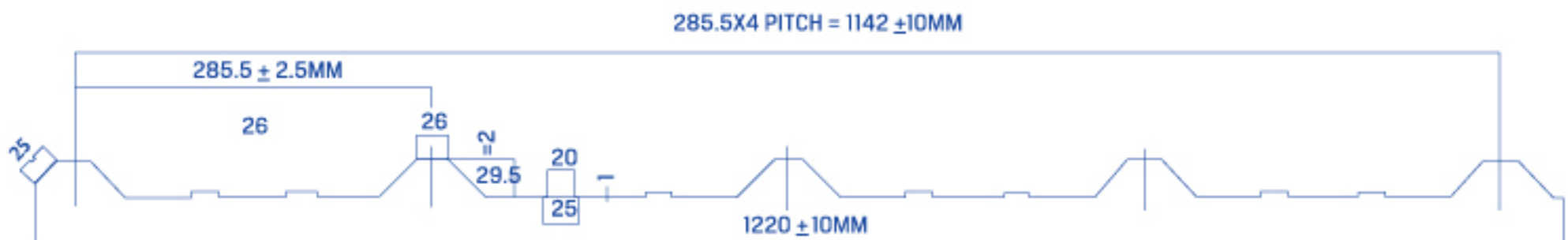

DOUBLE RIBBED TRAPEZOIDAL PROFILE

Thickness (TCTP in mm)	0.45 & 0.50
Effective Cover Width (mm)	1060
Overall Width (mm)	1142
Pitch (mm)	265 +/- 2.5
Crest Height (mm)	29 +/- 2
Length (ft)	8, 10, 12, 14, 16, 18, 20, 22, 24
Substrate	PPGL

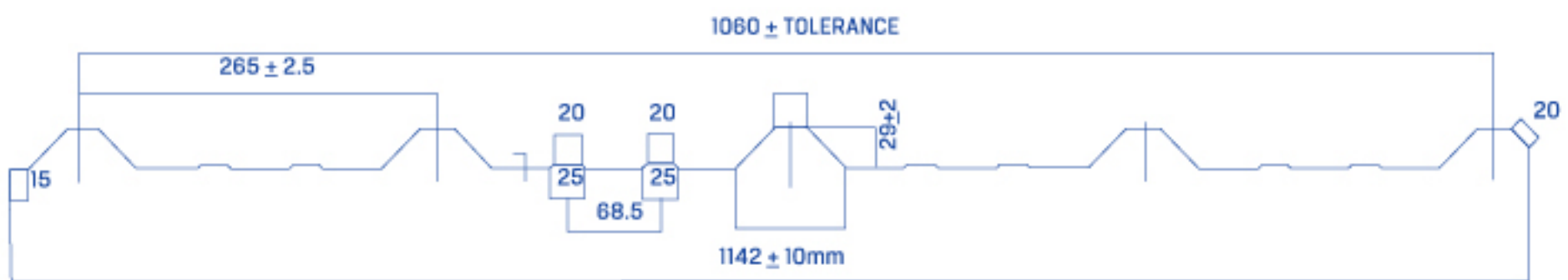

SINGLE RIBBED TRAPEZOIDAL PROFILE

Thickness (TCTP in mm)	0.45 to 0.80
Effective Cover Width (mm)	975
Overall Width (mm)	1057
Pitch (mm)	195 +/- 2.5
Crest Height (mm)	32 +/- 2
Length (ft)	8, 10, 12, 14, 16, 18, 20, 22, 24
Substrate	PPGL

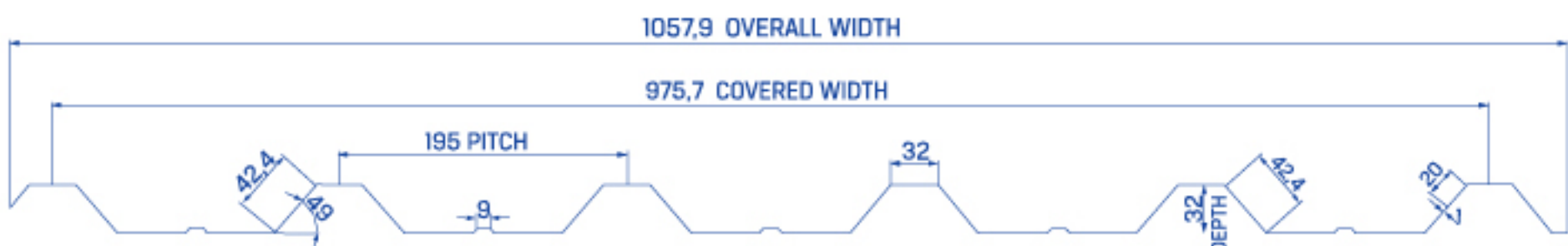
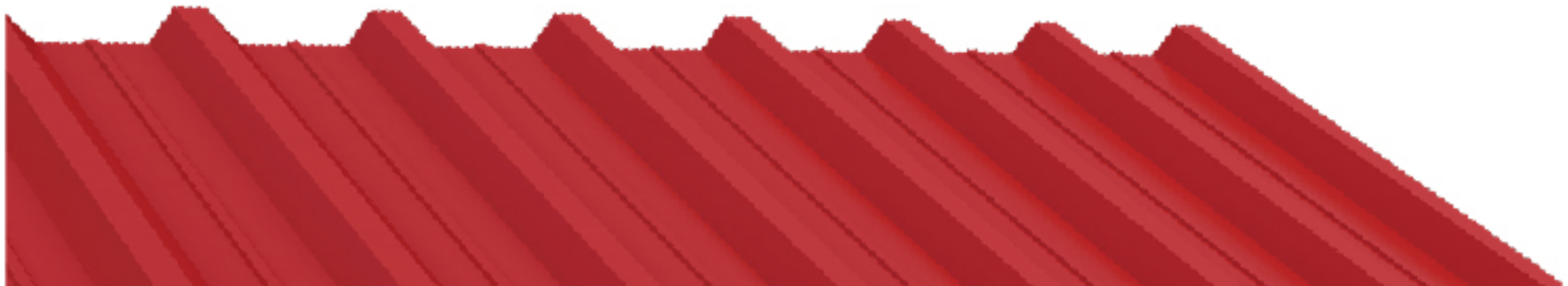

TRAPEZOIDAL PROFILE WITHOUT RIB

Thickness (TCTP in mm)	0.45 to 0.80
Effective Cover Width (mm)	980
Overall Width (mm)	1060
Pitch (mm)	196 +/- 2.5
Crest Height (mm)	32 +/- 2
Length (ft)	8, 10, 12, 14, 16, 18, 20, 22, 24
Substrate	PPGL

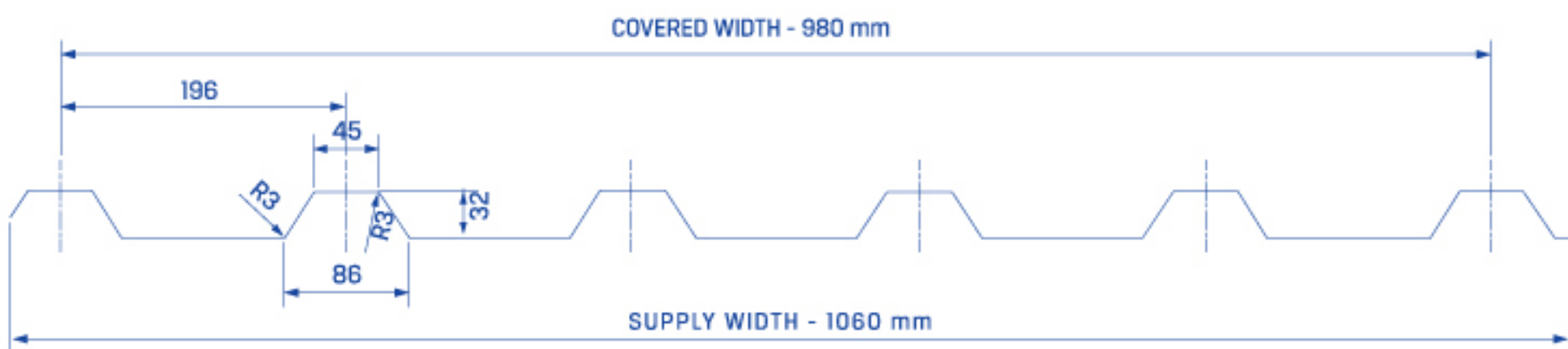
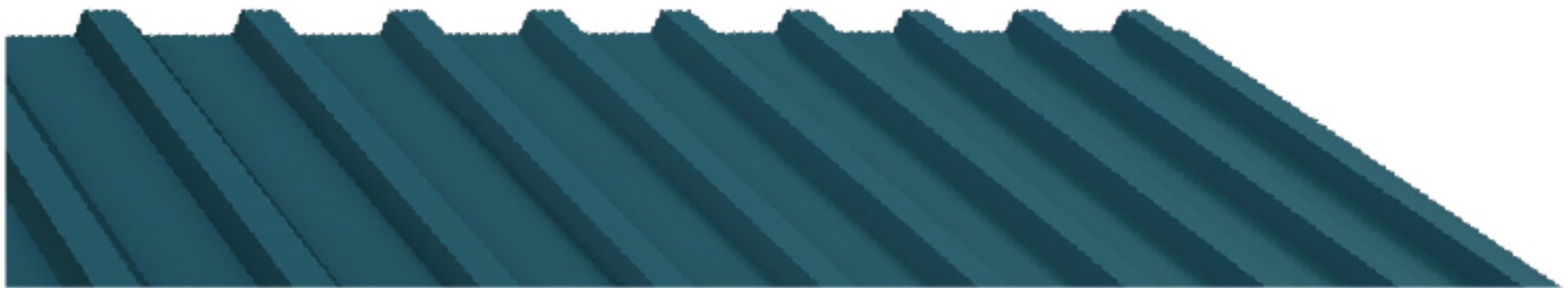

MANGALORE TILE PROFILE

Thickness (TCTP in mm)	0.30 to 0.80
Effective Cover Width (mm)	990
Overall Width (mm)	1090
Pitch (mm)	198 +/- 2.5
Crest Height (mm)	NA
Length (ft)	8, 10, 12, 14, 16, 18, 20, 22, 24
Substrate	PPGL

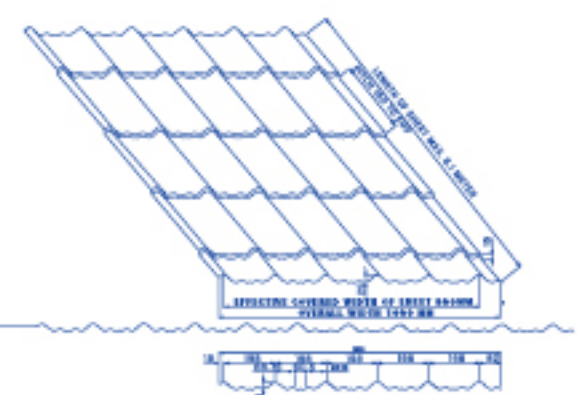
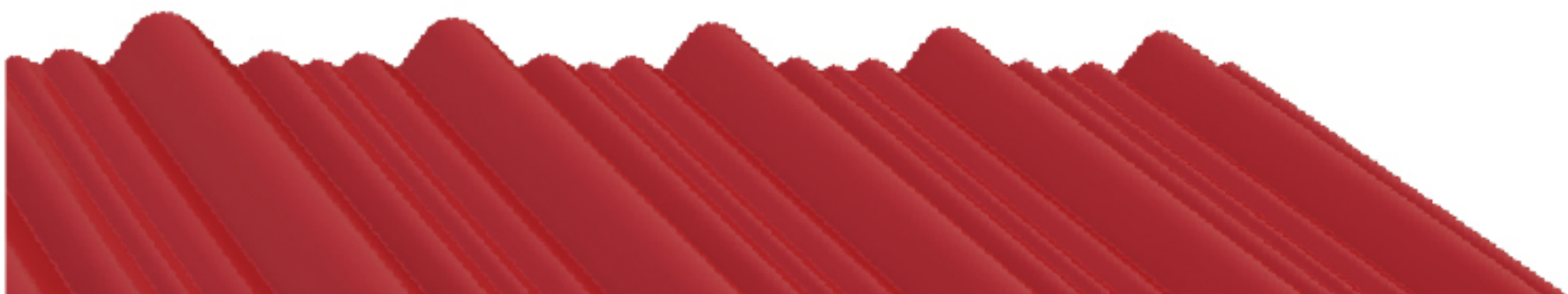

CORRUGATED / SINUSOIDAL PROFILE

Thickness (TCTP in mm)	0.22 to 0.80
Supply Width (mm)	800/910/1120/1220
No. of Valleys	10/12/14/16
Pitch (mm)	75.5 +/- 2.5
Crest Height (mm)	16.5 +/- 1.5
Length (ft)	8, 10, 12, 14, 16
Substrate	PPGL

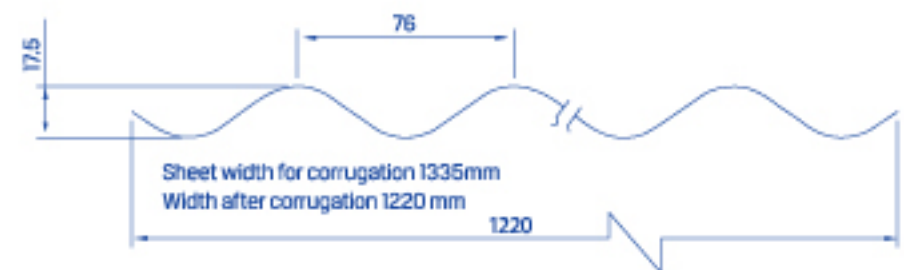
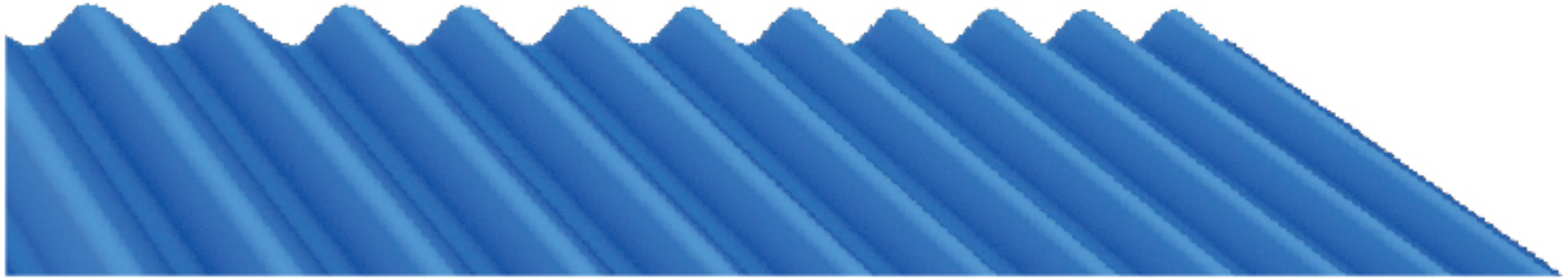

INSTALLATION

Placement of Groove Portion

- ✓ **Right way**
The groove portion should be on the inner side. The air gap on the left ensures that water does not travel upwards
- ✗ **Wrong way**
The groove portion should not be on the outer side. Improper contact makes the roof vulnerable to water leakages



Proper fastener installation procedures to be followed

- ✗ **Do not Allow contact with cement**
Direct contact with cement foundation, is not recommended for colour coated sheets. Accelerated corrosion can occur due to the lime contained in the cement
- ✗ **Do not leave metal filings on the sheets**
Metal debris from sawing, drilling and other construction processes should be removed during installation. Otherwise, the metal filings will red rust on the surfaces where they were deposited. Red rust of the metal filings may cause stain or discoloration on the surface of the panel
- ✗ **Don't install the roof sheets during rains as sheets gets wet and slippery and can cause damage to the sheets**
- ✗ **It is important that shoes do not have small stones, steel drillings, etc embedded into the soles**
- ✗ **Do not allow dirt accumulation on the sheets**



STORAGE AND HANDLING

If colour coated sheets are to be stored for any time prior to forming or installation, they must be stored in dry, well ventilated conditions. Storage which allows water (including condensation) to be trapped between the sheets may damage the coating beyond repair

DO's

- ✓ Always keep material in a dry, shaded and good ventilated area
- ✓ If not required for immediate use, provide cover to protect the material
- ✓ If Sheets become wet during storage, it should be separated without delay & surface moisture removed with clean cloth. The steel sheets then be stacked so that air circulation completes the drying process
- ✓ Material to be kept slightly above the ground by using wooden rubber plank

Dont's

- ✗ Do not keep the material on wet floor (water, rain. etc.)
- ✗ Moisture or water penetration between the sheets through the wooden pallets which causes damage hence to be avoided
- ✗ Prevent water seepage inside the packed coils and packets
- ✗ Metal-on-metal contact should be avoided whenever possible
- ✗ Under no circumstances should the material be stored near or come in contact with salt water, corrosive chemicals, ash, or fumes generated or released inside the building or nearby plants, foundries, plating works, kilns, fertilizer, and wet or green lumber
- ✗ Do not slide sheet on rough surface or over each other
- ✗ Contact with water and mud should be strictly prohibited



MARK OF INGENUITY

All genuine JSW Colouron+ sheets come with special non-erasable liner marking.
The below liner markings have been created to ensure that you get the original high quality product.

NON-ERASABLE LINER MARKING

JSW COLOURON+

JSW COLOURON + 0.50 MM AZ-70

JSW COLOURON+ (GALVALUME)

JSW COLOURON + 0.50 MM AZ-150 GALVALUME



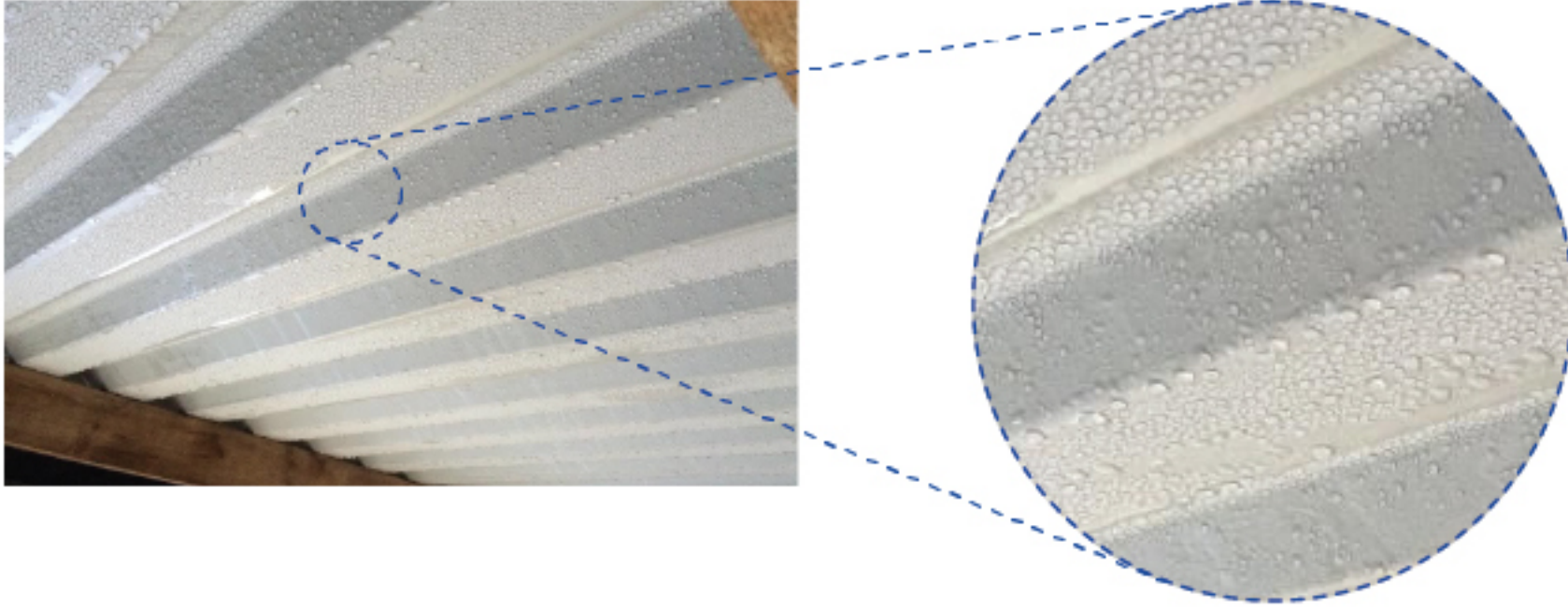

Disclaimer on Condensation:

Condensation is the natural formation of water droplets on the bottom side of any installed metal roofing sheet. It may occur when there is a difference in temperature between the air in the building and the sheet itself, causing the water vapour (moisture) in the air to condense on the inside of the sheet. It is a natural phenomenon and hence no claims will be entertained in this regard.

The risk of condensation may be minimised by providing proper ventilation arrangement in the roofs and by using suitable insulation.

JSW Centre, Bandra Kurla Complex, Bandra (East),
Mumbai - 400 051.

DISTRIBUTOR'S ADDRESS:

Toll-free No: 1800-225-225
Website: www.jswcolouron.in
Email: jswcolouron@jsw.in

The logo for JSW Steel, featuring the letters 'JSW' in a bold, blue, sans-serif font, followed by the word 'Steel' in a smaller, blue, sans-serif font. A red swoosh underline is positioned beneath the 'JSW' letters.